

V-25-AF8 Lift-A-Lift®

Forklift Service Lift

**Fast, Safe and Easy Maintenance for
Forklifts • Industrial Vehicles • Light Trucks**

Tilt-Or-Lift, Inc., the leading designer of specialty lifts since 1973, has raised the art of forklift maintenance to new heights with the Lift-A-Lift® forklift service lift.

The Lift-A-Lift service lift model V-25-AF8 is designed to allow complete access to underside parts of forklifts, industrial trucks and motor vehicles for lubrication, repair or part replacement. Just drive the vehicle onto the 22 inch wide runways. The self-leveling lift raises the vehicle up to 72" so all service and maintenance can be done while standing.

High Marks for Safety and Versatility

The Lift-A-Lift service lift complies with applicable ANSI and OSHA requirements. Automatic safety pawls are incorporated in the design to prevent accidents in the event of hydraulic failure.

The Lift-A-Lift service lift is portable and has removable runway panels and floor beam for easier access. Standard 22 inch wide runways and 66 inch wide entry width accommodate a wide range of vehicles. This lift has a capacity of 25,000 or 30,000 pounds. A wide variety of popular options is available to enhance its versatility. All lifts are shipped assembled, factory tested and carry a full one-year warranty.

The Lift-A-Lift service lift; one of the fine family of forklift service lifts available from Tilt-Or-Lift, Inc. The lift specialists. There are no finer lifts available — anywhere.

“We stand under our products.”



**Manufacturers of
Forklift Maintenance Lifts**



V-25-AF8 Lift-A-Lift® Forklift Service Lift

Specifications

- Capacity: 25,000# G.V.W.
- Entry width: 64"
- Minimum ceiling height: 12'-7"
- Max runway height: 72"
- Safety locks are automatic
- Motor: 5 horsepower
- Power: 230/460/3/60
- Runways: 22" wide x 8' long
- Shipping weight: 7500#

Features

- Portable, hydraulic lift
- Auto safety locks
- Auto self-leveling system
- Removable runway panels
- Removable right-side floor beam
- Lockable control panels
- Shipped assembled and factory tested

Options

- Hydraulic motor/transmission jack
- Ramp: 5'-0" long
- Three wheel platform
- Wheel freeing device
- Upgrade to 30,000# capacity

ALL UNITS ARE SUBJECT TO CHANGE AND MODIFICATIONS

NOTE: Dimensions may change without notice.

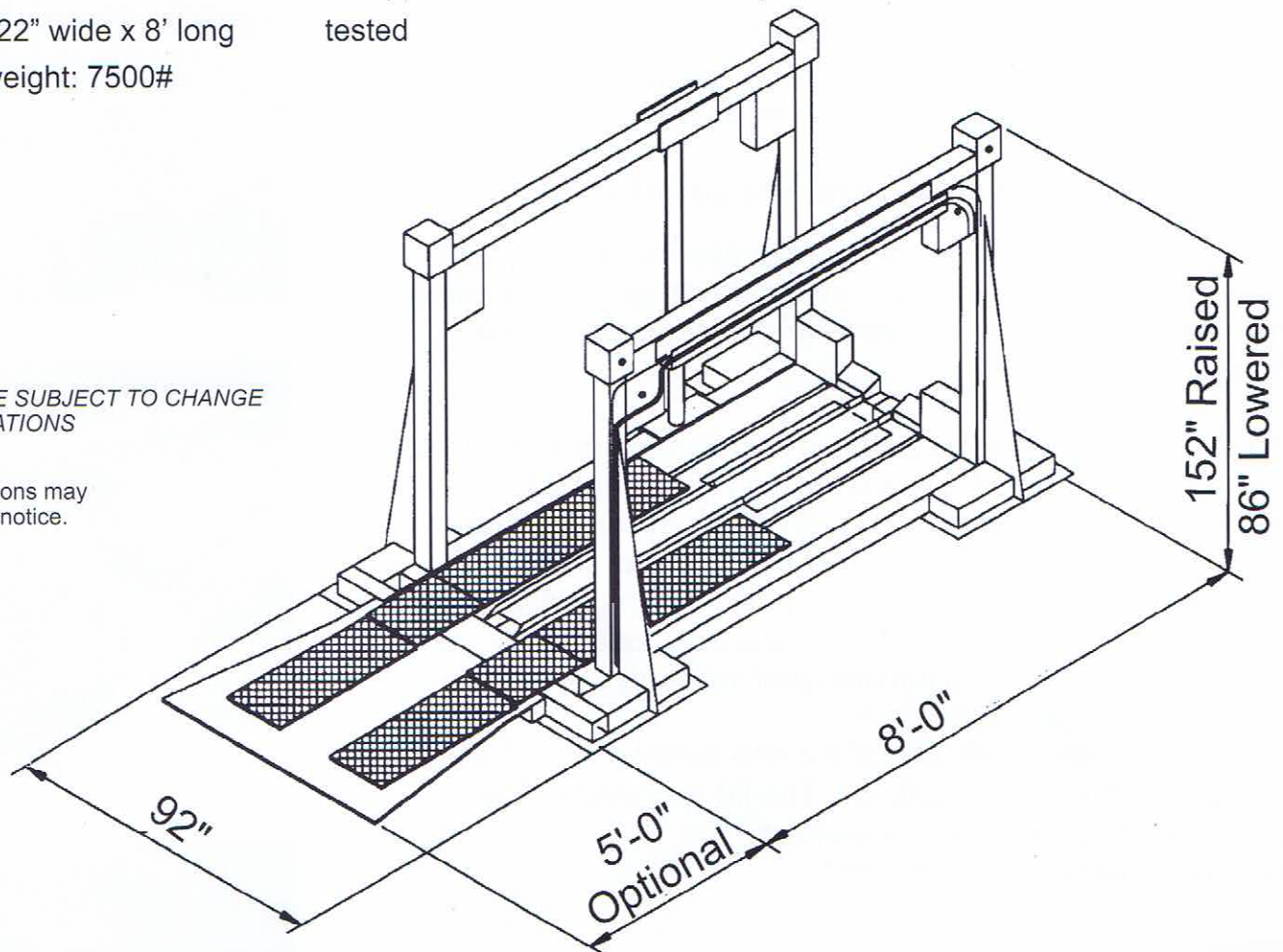

Manufacturers of
Forklift Maintenance Lifts