

Newcastle Company, Inc.

Lifts Tables, Turntables and Tilt Tables 600 Series

Phone: 724-658-4516 ■ Fax: 724-658-5100 ■ E-Mail: ncco@newcastleco.com



G-635



G-635



G-635 with Squaring Plates



G-685

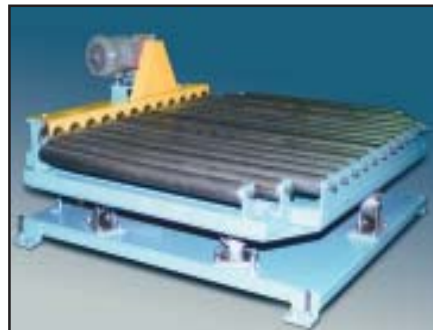

G-617

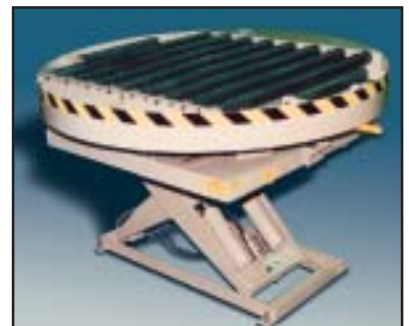

G-657

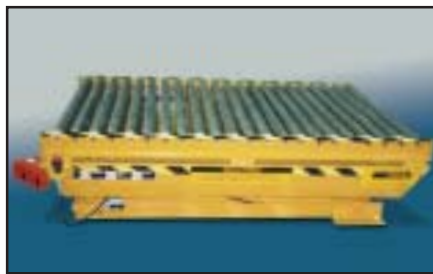

G-640

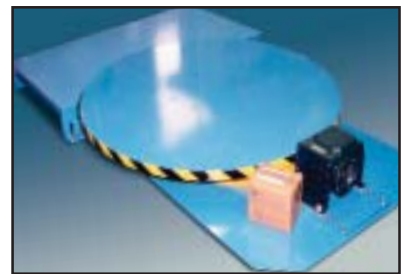

G-610

Newcastle Company, Inc.

Lifts Tables, Turntables and Tilt Tables 600 Series

Phone: 724-658-4516 ■ Fax: 724-658-5100 ■ E-Mail: ncco@newcastleco.com



G-605 Manual Turntable with Detent Stop

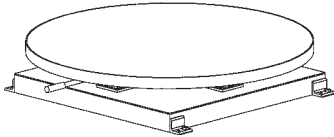

G-610 Power Turntable

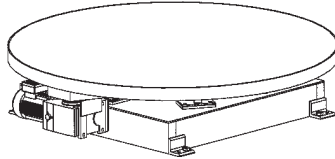

G-612 Manual Turntable with Gravity Roller Conveyor

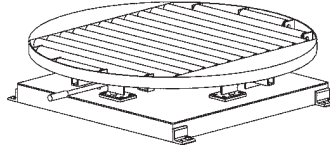

G-617 Manual Turntable with Chain Driven Live Rollers

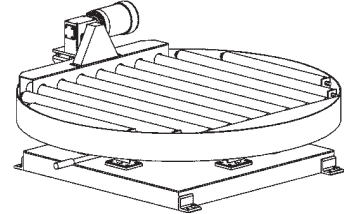

G-615 Power Turntable with Gravity Roller Conveyor

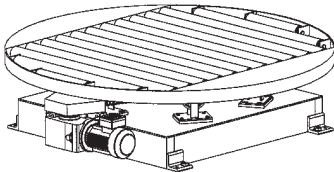

G-620 Power Turntable with Chain Driven Live Rollers

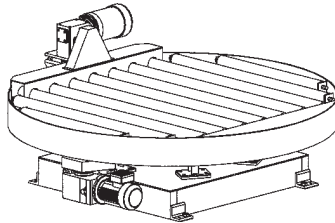

G-621 Tilt Table

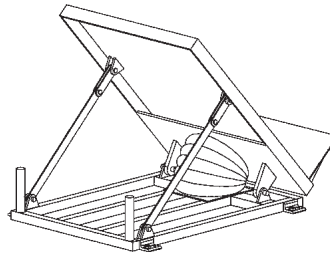

G-635 Hydraulic Scissor Lift with Manual Turntable

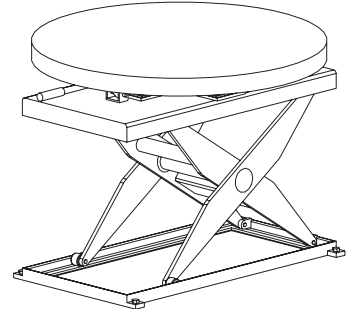

G-627 Low Profile Scissor Lift Table with Pallet Jack Ramp

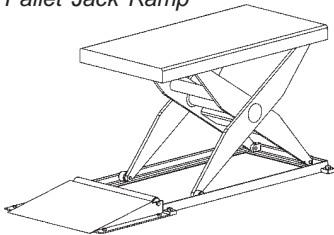

G-625 Self-Contained Hydraulic Lift Table

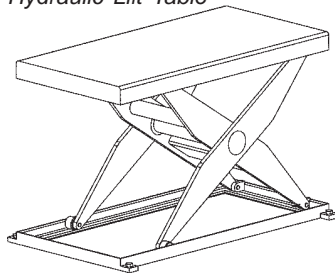

G-628 Floor Height Lift Table

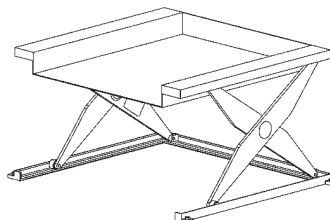

G-630 Scissor Lift

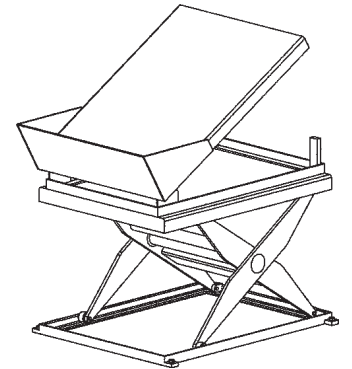

G-640 Scissor Lift

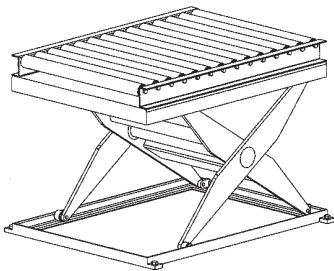

G-645 Scissor Lift with Chain Driven Live Rollers

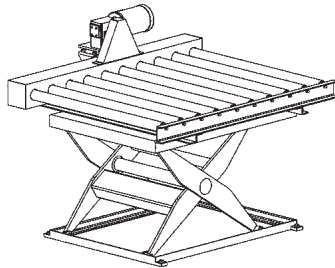

G-660 Scissor Lift with Power Turntable and Gravity Rollers

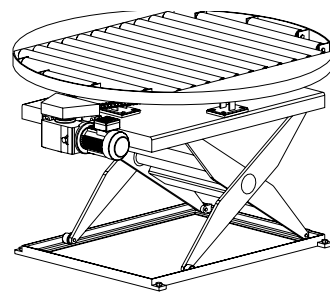

G-657 Scissor Lift with Turntable and Gravity Rollers

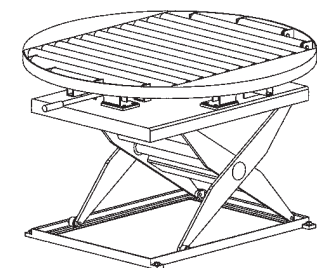

G-658 Scissor Lift with Manual Turntable and Power Rollers

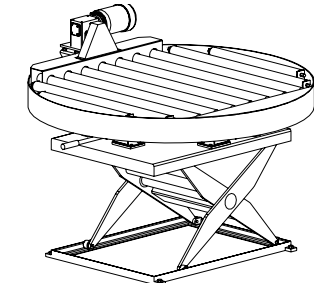

G-650 Scissor Lift with Power Turntable

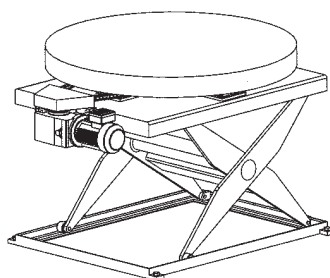

G-685 Scissor Lift with Power Turntable and Chain Driven Live Rollers

