

# Newcastle Company, Inc.

## Floor Level Automatic Bag Palletizer Model 100-57B

Phone: 724-658-4516 ■ Fax: 724-658-5100 ■ E-Mail: [ncco@newcastleco.com](mailto:ncco@newcastleco.com)



100-57B Automatic Bag Palletizer

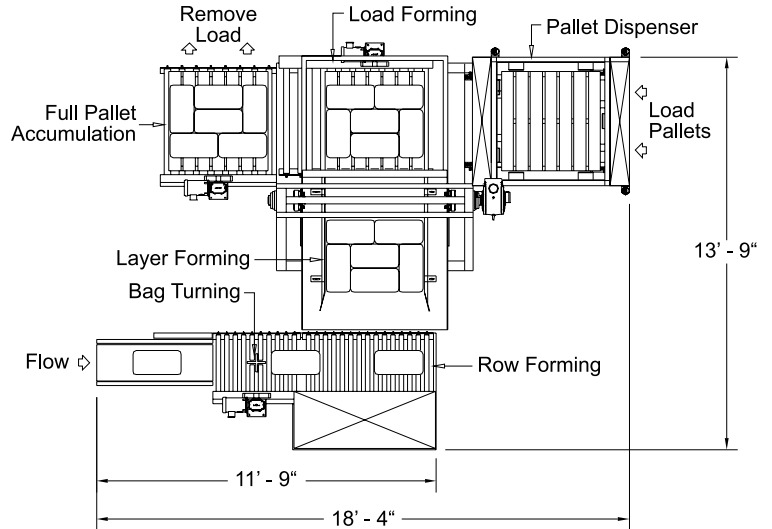

### Description

The 100-57B is designed to automatically palletize full bags onto a pallet or slip sheet. Operations are performed at floor level. Up to ten bags per minute can be handled.

### Operation

Empty pallets or sheets are stored in a magazine and dispensed into position for bag placement. A power infeed conveyor stages bags prior to orienting. An elevating table lifts bags and rotates them to form the required tier pattern. Bags are then transferred to a stripper plate with push bar. The stripper plate raises to discharge height and places formed layer on a pallet or sheet. Full pallets are discharged for removal by fork truck.

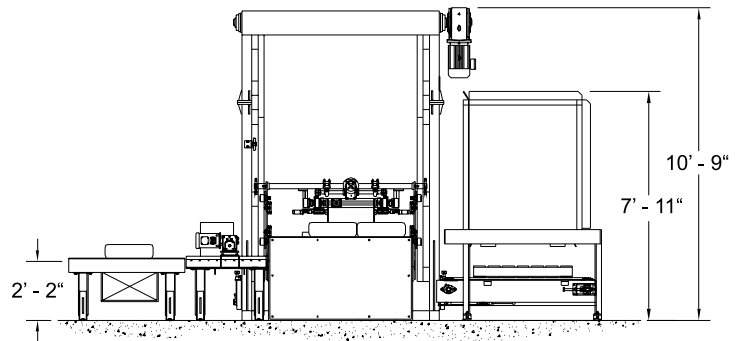

### Accessories

100-57B-GS  
Glue System

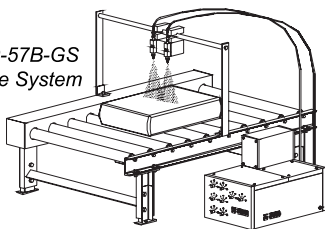

100-57B-PRC  
Pivoting Reject  
Conveyor

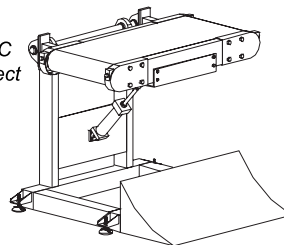

100-57B-SC  
Scale Conveyor

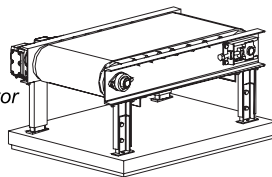

100-57B-RC  
Reject Conveyor

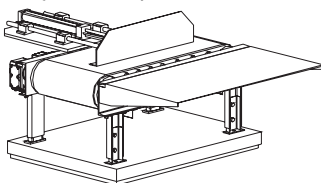

100-57B-TS  
Slip Sheet  
Dispenser

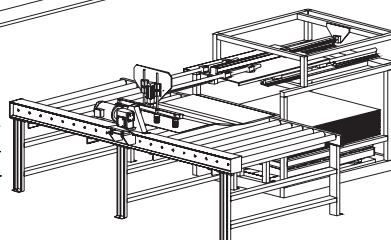

### Bag Patterns

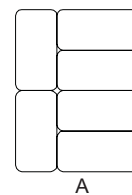

A

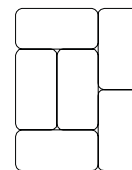

B

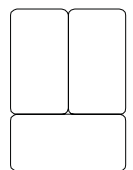

C

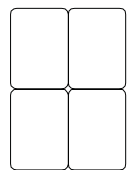

D

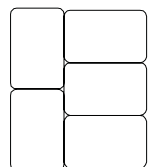

E