



Product Side Guides



FIXED ANGLE SIDE GUIDES



FIXED ANGLE SIDE GUIDES



ADJUSTABLE ANGLE SIDE GUIDES



ADJUSTABLE ANGLE SIDE GUIDES



UHMW LINED FIXED ANGLE SIDE GUIDES



UHMW LINED FIXED ANGLE SIDE GUIDES



ADJUSTABLE RAIL UHMW SIDE GUIDES



SKATEWHEEL SIDE GUIDES



SKATEWHEEL SIDE GUIDES



BEAD RAIL SIDE GUIDES



ROLLER SIDE GUIDES



ROLLER SIDE GUIDES



Side Guides - Available in fixed or adjustable with multiple contact surfaces. Allows product to be guided and kept in place within the conveying surface. Side guides are bolted to the conveying frame.

Fixed Angle Side Guides - Standard 1 1/2" x 2" high or 1 1/2" x 6" high formed, 10 ga. angle.

Fixed Channel Side Guides - Standard 2 1/2" high or 3 1/2" high, 10 ga. formed channel.

UHMW Fixed Angle Side Guides - Replaceable UHMW face provides wear protection on rails, width and height adjustable.

Tall Fixed Channel Side Guides - Higher formed angle for tall product.

Tall Fixed Channel Side Guides with Gussets - Higher formed and gusseted angle for tall product.

Tall Fixed Channel Side Guides with Threaded Rod - Higher formed angle with threaded rod adjustment for tall product.

Fixed Angle Side Guides with Spacer Bar - Spacer bar allows side guide to overlap belt to remove gap.

Skatewheel Side Guides - Vertically mounted skatewheels.

Side Guides with Belt Skirts - Belt Skirts attached to formed angle to keep product off the belt edges.

Flared Side Guides - Funnel type side guides for guiding product during loading (v-guided belt only)

Bead Rail Side Guides - Vertically mounted, tightly spaced small wheels supported by axles and a metal channel.

Roller Side Guides - Vertically mounted rollers.

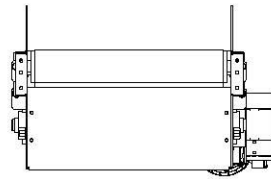

FIXED ANGLE SIDE GUIDES

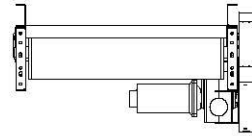

FIXED CHANNEL SIDE GUIDES

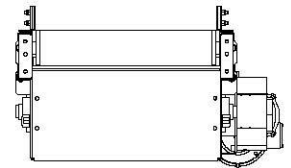

UHMW FIXED ANGLE SIDE GUIDES



ADJUSTABLE RAIL UHMW SIDE GUIDES

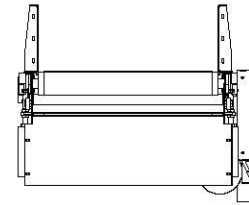

TALL FIXED CHANNEL SIDE GUIDES

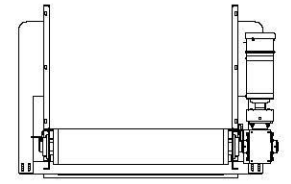

TALL FIXED CHANNEL SIDE GUIDES WITH GUSSETS

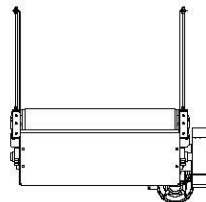

TALL FIXED CHANNEL SIDE GUIDES WITH THREADED ROD

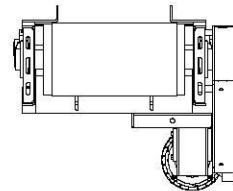

FIXED ANGLE SIDE GUIDES WITH SPACER BAR

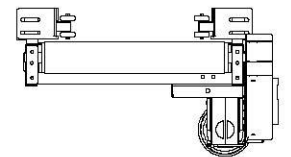

SKATEWHEEL SIDE GUIDES

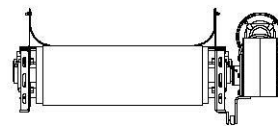

SIDE GUIDES WITH BELT SKIRTS

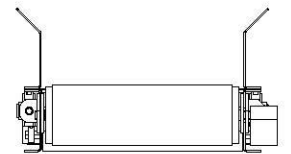

FLARED SIDE GUIDES SIDE GUIDES

GUARD RAILS GUARD RAILS



MODEL GC

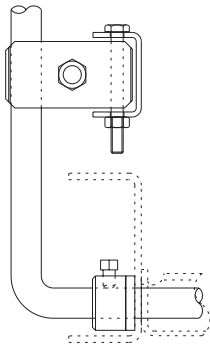

**MODEL GA1.5
MODEL HGA1.5**

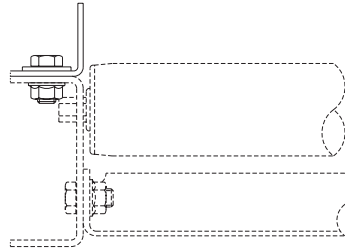

ALWAYS SPECIFY CONVEYOR MODEL NUMBER AND FLANGE WIDTH GUARD RAILS WILL MOUNT ON

MODEL FSG

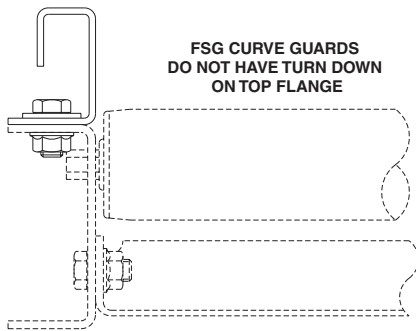

MODEL FC

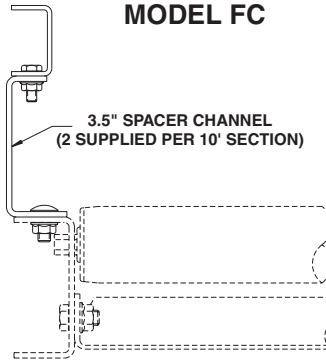

SPECIFICATIONS

CONSTRUCTION: All medium duty rails are 12 ga. HRS steel; heavy duty rails are 7 ga. HRS steel; all are powder painted EXCEPT guard rails for light duty conveyors normally supplied with galv. or alum. frames which are galv.; with mounting holes.

GUARD RAILS: Available in several styles; model GC, adjustable channel guards; model FC, fixed channel guards; model GA1.5, angle guards (1.5" high); model HGA1.5, heavy duty angle guards (1.5" high); model FSG, formed steel guards (7 heights from 2" to 24" high). Specify both sides or outside only when ordering AND conveyor model number to ensure receipt of proper guard rails & mounting hardware which is supplied as required.

GUARD RAIL MODEL NO.	WT./FT. (lbs.) BOTH SIDES
GC	3.9
FC	3.5
GA1.5	2.3
FSG-2	4.2
FSG-4	5.7
FSG-6	7.2
HGA1.5	4.0

**MODEL GC GUARD RAILS MODEL NO.
GC-90-15**

GC-(degree or length)-(between frames)

GA1.5 GUARD RAILS MODEL NO. (STRAIGHT)

GA-1.5-1.5-60

(model*)-(guard height)-(bottom flange**)-(length)

*Specify GA or HGA for heavy duty guard rails.

**Specify .75", 1" or 1.5".

**GA1.5 GUARD RAILS MODEL NO. (CURVE)
GGA1.51.59032.513**

(GGA1.5 or PGA1.5*) (bottom flange**) (degree#)

(radius##) (assembly code@)

*Specify GGA1.5 for galv.-to be used only on models supplied w/ galv. or alum. frames; PGA1.5 for painted.

**Specify .75", 1" or 1.5".

#Specify 30°, 45°, 60° or 90°.

##Specify applicable inside radius or outside radius.

@Specify N for inside guard only, U for outside guard only or between frames width for guards on both sides.

FSG GUARD RAILS MODEL NO. (STRAIGHT)

FSG-4-C-36

FSG-(guard height*)-(bottom flange**)-(length)

*Specify 2, 4 or 6.

**Specify .75" or 1.5".

**FSG GUARD RAILS MODEL NO. (CURVE)
GFSG2-1.59032.5U**

(model*) (guard height**) (bottom flange#) (degree##)

(radius@) (assembly code@@)

*Specify GFSG for galv.-to be used only on models supplied w/ galv. or alum. frames; or PFSG for painted.

**Specify 2, 4, 6, 8, 12, 18 or 24

#Specify .75", 1" or 1.5".

##Specify 30°, 45°, 60° or 90°.

@Specify applicable inside radius or outside radius.

@@Specify N for inside guard only, U for outside guard only or between frames width for guards on both sides.

MODEL FC GUARD RAILS MODEL NO

FC-60-39

FC-(degree or length)-(between frames)

■ 24 hour shipment