

Cable King[™] Wire Rope Electric Hoists



AMERICA'S FIRST NAME IN INDUSTRIAL LIFTING

Cable King™

Electric Wire Rope Hoists

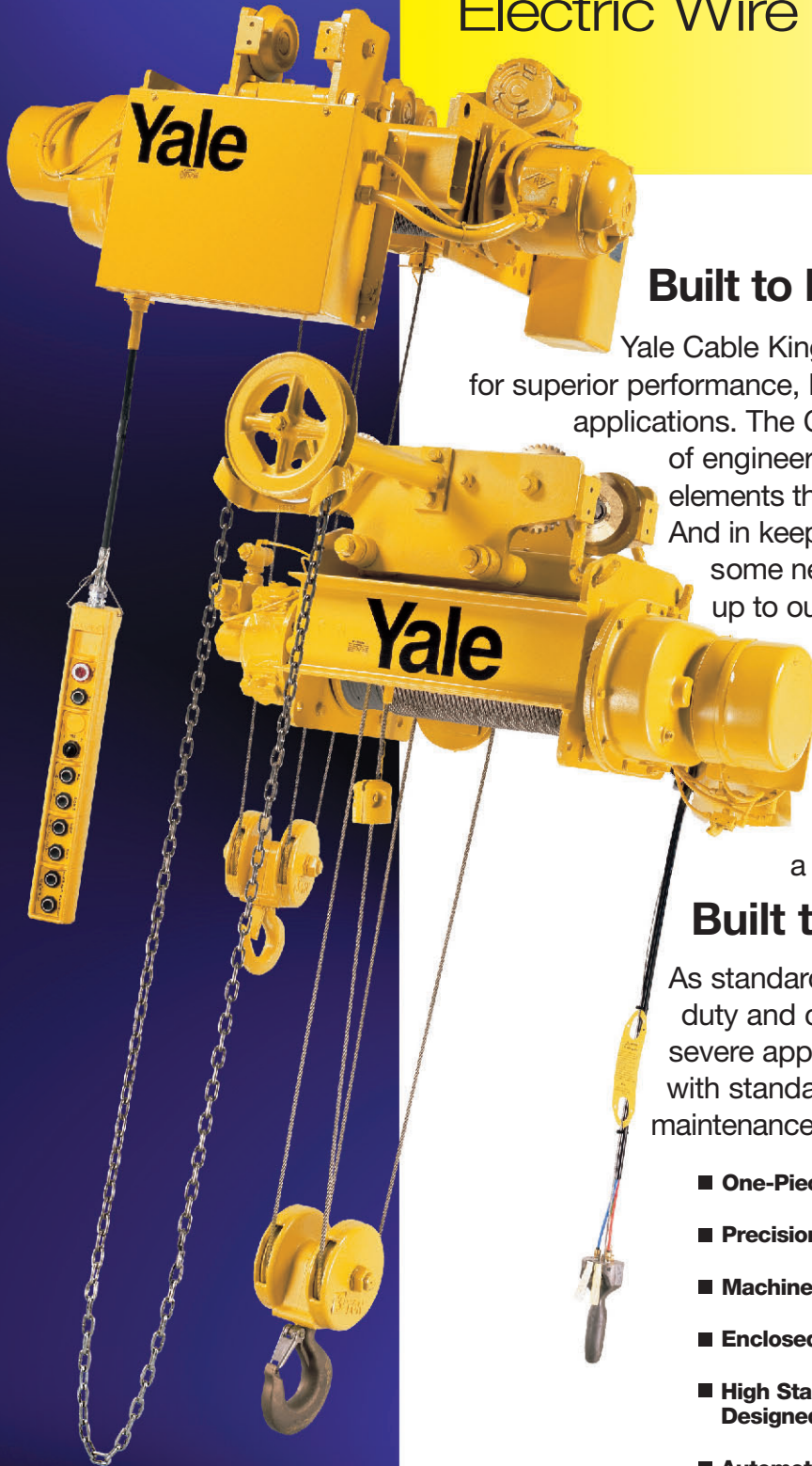

Built to last.

Yale Cable King hoists have a well-deserved reputation for superior performance, low maintenance, and longevity in heavy-duty applications. The Cable King hoist is the result of years of engineering that builds on time tested design elements that have proven so successful in the past. And in keeping with our innovative tradition, we incorporated some new ones. The result is a hoist line that lives up to our own tough standards of dependability and durability. And with the capability of longer lifts and greater capacities, you'll find a Yale hoist to fit your needs and receive more value for your investment. When you buy a Cable King hoist, you buy it with confidence that it will be on the job for a long time to come.

Built to perform.

As standard, Cable King hoists are rated for Class H-4 duty and can be configured for Class H-5 duty for more severe applications. Cable King hoists are also loaded with standard features that enhance performance, reduce maintenance costs and increase longevity. Features such as:

- One-Piece Welded Steel Frame
- Precision Spur Gearing
- Machined Steel Rope Drum
- Enclosed Bottom Blocks with 360° Hook Rotation
- High Starting Torque Motor
Designed Especially for Hoisting Service
- Automotive-Type Drive Shaft for a
smooth running, long-lasting drive
- Weston Screw-Type Load Brake and
Disk-Type AC Motor Brakes
- Wide Variety of Controls
- Upper and Lower Adjustable and Upper Block-
Operated Control Circuit Limit Switches

With Yale hoists,
quality is not an option,
it is standard.

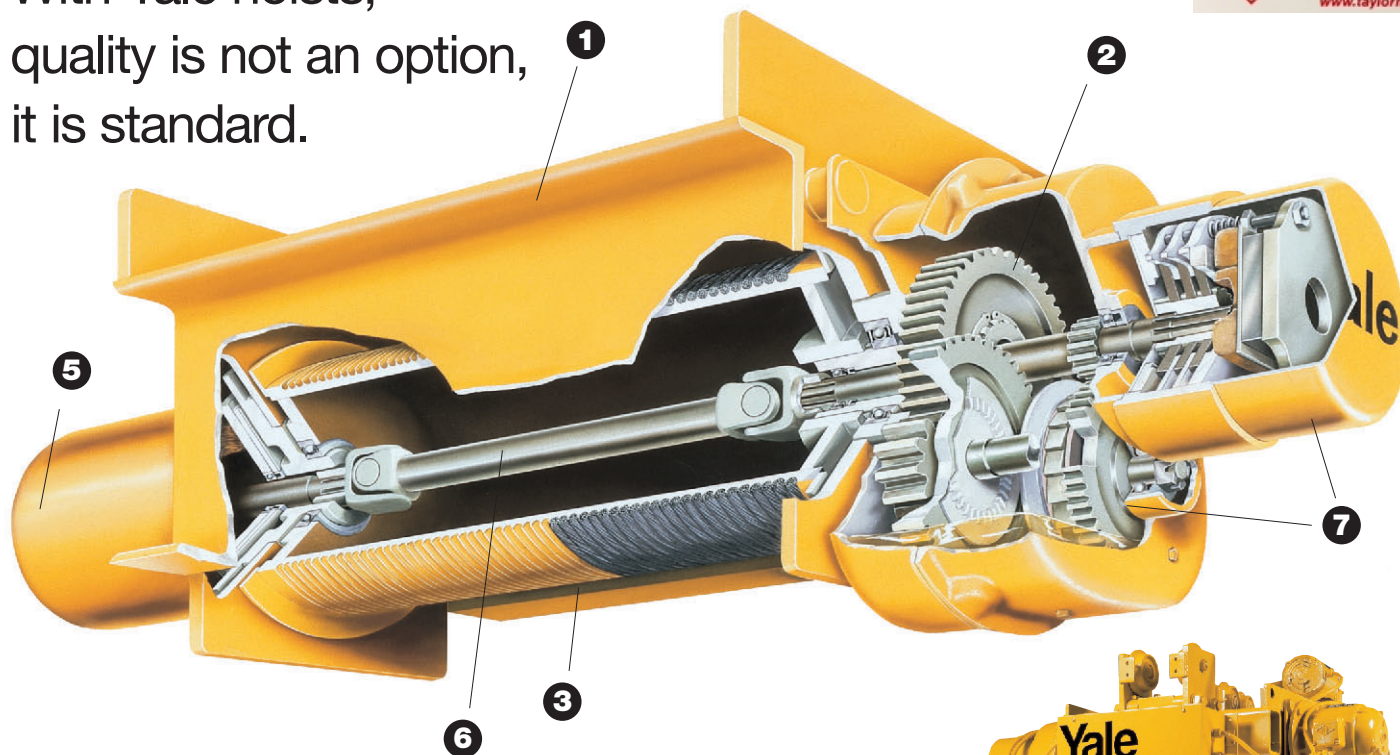

Inside the Cable King

Some of the standard features of the Cable King are:

- 1 Frame**
One-piece welded steel made from heavy structural shapes provides a rugged, and durable foundation for precise mounting and alignment of the hoisting machinery.
- 2 Gearing**
Precision spur gearing machined from high-alloy steel or drop forgings is case hardened for quiet operation and long life. Gearing operates in a precision machined ductile iron or steel gearcase and is oil bath lubricated.
- 3 Rope Drum**
Fabricated steel drum machined with grooving cuts up to 50% of the rope's diameter to guard against the rope jumping out of the groove, which can damage and weaken the rope.
- 4 Bottom Blocks**
Enclosed blocks with 360 degree hook rotation. All hooks provided with a spring loaded hook latch as standard.
- 5 Motors**
High starting torque made especially for hoisting service. The motors are TENV, 30-minute rated with class F insulation and thermostats as standard.
- 6 Automotive-type drive shaft**
Borrowing from the automotive industry, Cable King hoists incorporated a smooth running, long-lasting drive shaft for effective power transmission from the motor to the drive gearing.
- 7 Brakes**
Weston screw-type load control brake and disk-type AC motor brake rated at a minimum 125% of the motor's torque.
- 8 Controls**
One and two speed and variable frequency housed in a NEMA 12 enclosure as standard. The 115-volt control circuit is fused.
- 9 Limit Switch**
As standard an upper and lower adjustable geared control circuit limit switch is provided along with an upper block-plugging limit switch.

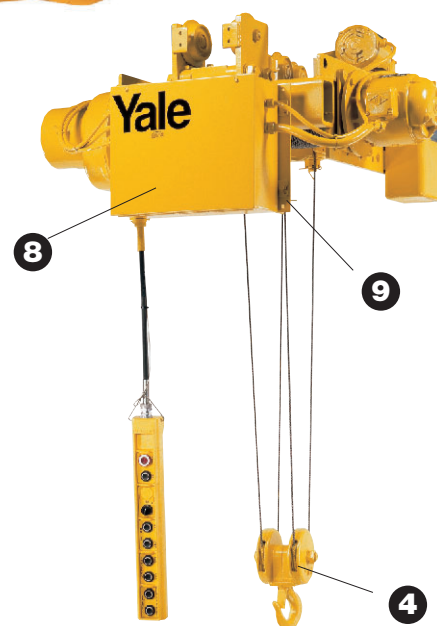

- 1/2 to 35-ton capacity
- Designed and built to meet the standards of ASME
- Available in monorail, base, and deck mounted and top-running versions
- Available for air operation
- Available in spark resistant and explosion proof versions

Optional Features

- Non-cataloged lifts and speeds
- Hot metal applications
- Car shaker applications
- Bucket hoists
- Marine duty offshore applications
- Special paint finishes
- Winch applications

Cable King Standard and Optional Features

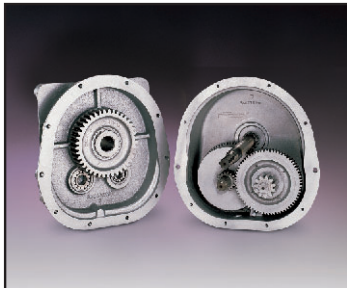

Gearing

Precision spur machined from high-alloy steel or drop forgings and case hardened for long life and quiet operation. Gearing operates in a precision machined ductile iron or steel gearcase and is continuous oil bath lubricated to reduce maintenance and increase life.



Mechanical Load Brake

Fully automatic in operation and adjustment. Weston design load control brake operates with or without power.



Wire Rope Drum

Drums are fabricated from steel tubing and grooved to a depth of up to 50% of the rope's diameter to guard against the rope jumping out of the groove, which can damage and weaken the rope.



Motors

Cable King motors are high starting torque built especially for hoisting applications. These high quality motors come standard as 30-minute rated with Class F insulation and thermal overloads built into the windings.

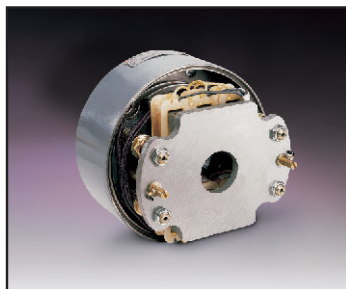

AC Motor Brake

The Cable King uses an AC-type gearcase mounted disc brake. Its features include precise load spotting capabilities and more efficient power consumption than other types of hoisting brakes. Electrically released and spring set, the brake operates automatically upon loss of power.



Upper Block-Operated Limit Switch (Except Winches)

In addition to the geared limit switch, an upper block-operated control circuit limit switch is provided as standard. The limit switch is activated by the lower block and contains a reverse plugging feature that will momentarily reverse the direction of the hoist if the block continues to travel too high.

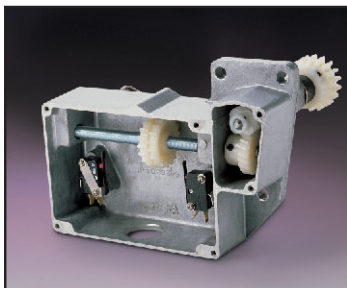

Geared Limit Switch

Heavy-duty, adjustable geared upper and lower control circuit limit switch is standard on all Cable King hoists.



Trolleys

Yale Cable King hoists are available with hand-push, hand-gear or motor-driven trolleys for use on wide-flange, I-beam or patented track.

Many Options are available

- Fusing to meet NEC requirements dependant on application
- Variable frequency control
- Radio Control
- High altitude applications
- Outdoor applications
- Explosion proof applications
- Spark resistant applications
- Long lifts

A story of innovation

In 1875 Linus Yale invented the “Differential Hoist” which started the modern hoisting industry in the United States and the company known today as Yale Hoists. Since the beginning, Yale has been synonymous with quality, durability and innovation. In 1879, a Yale engineer, Thomas Weston, invented the Weston Screw Load Brake, a mechanical load control brake, of which modern versions are still the industry standard today. Since the late 19th Century, scarcely a year has gone by without new, better hoists and improved features being introduced. In 1938, Frank Locke, an engineer recruited from the Krupp Works in Germany, developed the Cable King hoist. The Cable King was the first large capacity electric wire rope monorail hoist and is the predecessor of the modern Cable King line sold today.

The momentum that started over a century ago continues today at the Yale facility in Forrest City, Arkansas.

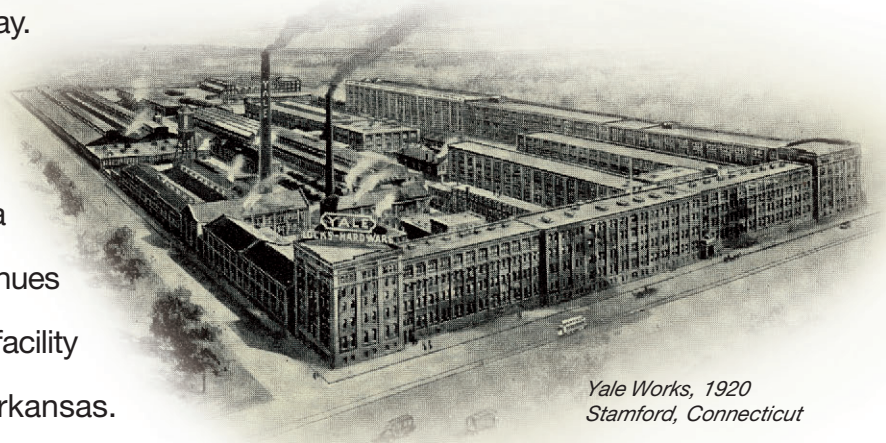

*Yale Works, 1920
Stamford, Connecticut*

Yale hoists are used in every country of the world in every kind of application imaginable. Quality, time-tested hoists for standard and special applications are the hallmarks of Yale. Yale hoists are sold through a worldwide organization of dealers. Parts and service depots are found in all major metropolitan areas around the globe. Well into its second century of existence, Yale is committed to maintaining the role as industry innovator and leader.

Yale



KNOW HOW...KNOW WHY

Columbus McKinnon is a global leader in providing expertise and training in the proper use and inspection of rigging and overhead lifting equipment. With a range of comprehensive programs and seminars conducted at venues throughout North America, as well as on site at private companies and industries, Columbus McKinnon courses include:

- Hoist Maintenance
- Load Securement
- Crane & Hoist Inspection
- Mobile Crane Operator
- Rigging
- Safe Hoisting
- Crane Operator Training
- Rigging Gear Inspection

In addition, classes are available at the new state-of-the-art **Hoist & Rigging Training Center of Excellence** in the Center for Occupational Health and Automobile Manufacturing (COHAM) lab located at The Ohio State University. The COHAM lab is a hands-on learning center which allows attendees to understand how to properly use and inspect overhead lifting equipment. This leading edge training program is designed to increase workplace productivity and safety in an ergonomically-friendly training environment.



In addition to the strong knowledge base exemplified by comprehensive training programs, Columbus McKinnon is one of the only manufacturers supplying complete lifting systems to satisfy unique material handling requirements of users in a variety of environments. From jib cranes and hoists to chain slings, clamps, and related attachments; systems include products that are matched specifically to the lifting needs of the application. Products may also be modified in order to ensure that the proper system is in place for the job.

Whether your needs call for a single hoist or a completely engineered system to outfit your production facility, Columbus McKinnon provides the products and expertise to keep your workforce productive and safe.



⚠ WARNING
To Avoid Injury:
 • Do not exceed working load limit, load rating, or capacity.
 • Do not use to lift people or loads over people.
 • Read and follow all instructions.



Phone: (800) 888.0985 • (716) 689.5400 • Fax: (716) 689.5644 • www.cmworks.com