

Newcastle Company, Inc.

Automatic Pallet Dispenser Model 50-57

Phone: 724-658-4516 ■ Fax: 724-658-5100 ■ E-Mail: ncco@newcastleco.com



Features

- Dispenses GMA, Chep, winged plastic pallets, skids and collapsible containers
- Automatic operation
- Two pallets per-minute cycle rate
- Fork truck loading
- Magazine capacities up to 40 pallets

Description

The 50-57 automatically dispenses pallets from a storage magazine. Units are available to discharge pallets inline or 90° to magazine loading.

Options

Stack of pallets is loaded into magazine with a fork truck. A hydraulic lift and pallet holding bars are utilized to dispense individual pallets. Single pallets are discharged with a powered conveyor installed inside dispenser.



Automatic Pallet Dispenser Model 50-57 with Magazine Extension

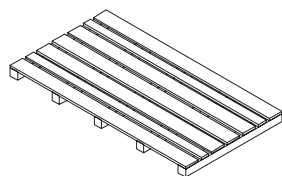

OVERSIZED PALLETS

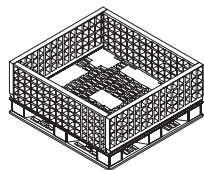

COLLAPSIBLE CONTAINERS (OPEN)

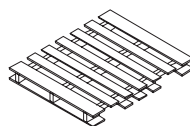

WINGED PALLETS

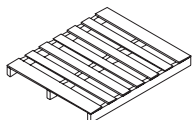
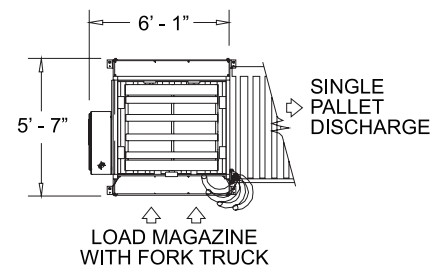

SKIDS (NO BOTTOM BOARDS)

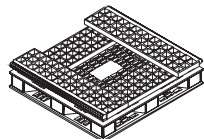

COLLAPSIBLE CONTAINERS (CLOSED)

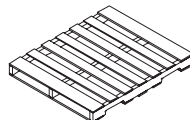

GMA PALLETS

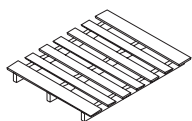
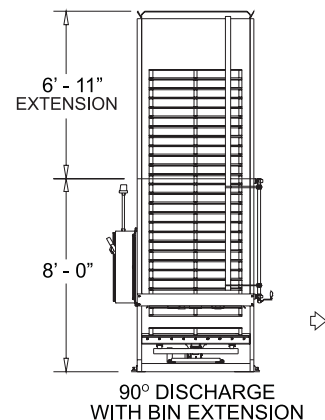

WINGED SKIDS

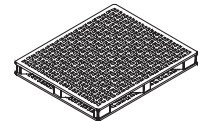

PLASTIC PALLETS

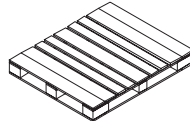

CHEP PALLETS