



# COLLISION AWARENESS **LOOK OUT**<sup>TM</sup>

**LEADERS OF INTERSECTION PROTECTION**



**NEW Outdoor Models Available!**



**Our Products  
Alert Employees Of  
Dangerous Collisions  
BEFORE They Occur!**



Proud Member



**Toll FREE: 888-324-1920**





# KEEP YOUR WORKFORCE PROTECTED!

We're the Leader in Intersection Protection. Our goal is to help your employees avoid accidents and reduce your exposure to liabilities.

**Collision Awareness** products are designed to monitor any traffic & alert others, just around the corner.

40% of all forklift fatalities are caused by an individual being struck or run over by a forklift.

Many of these accidents and fatalities can be avoided by warning pedestrians and operators of approaching danger.

Our **LOOK OUT** Sensor Alert Warning System allows for quick and easy recognition of possible hazardous situations. Why take chances of liabilities when you can avoid accidents and protect your most valuable assets?

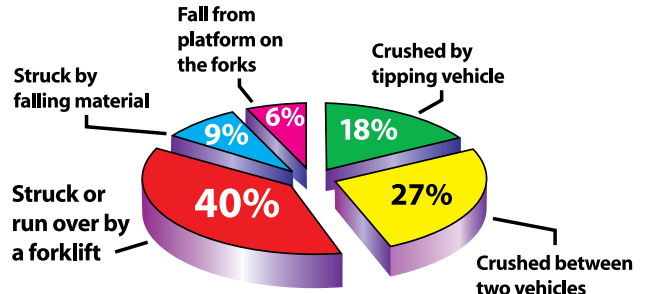

By creating awareness to a possible danger, you reduce the risk of damage, injury and death. Reducing risk should reduce your liability and exposure to workman's compensation claims, and increase employee morale as they see the company efforts to provide a safe workplace.

## NEW STATE-OF-THE-ART SENSORS



Collision Awareness chooses Bosch sensors as their standard sensor for the 36 standard package offerings. The quality and reputation of Bosch, together with Collision Awareness, continues to place us as the leaders of Intersection Protection. This upgrade improves the field of detection and reduces false alerts. Includes a blue sensor indicator light.

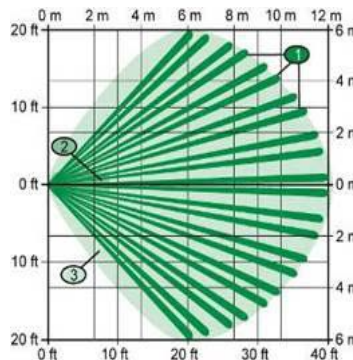

Top View

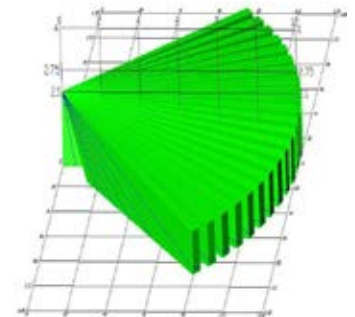

3D View

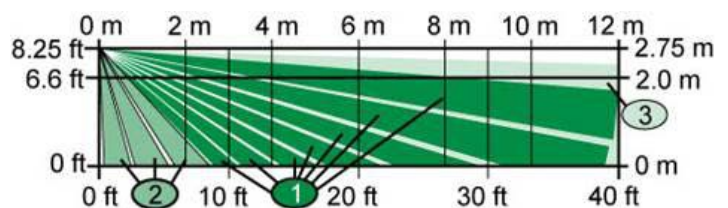

Side View



# LOOK OUT™ SENSORS

## PRODUCT FEATURES:

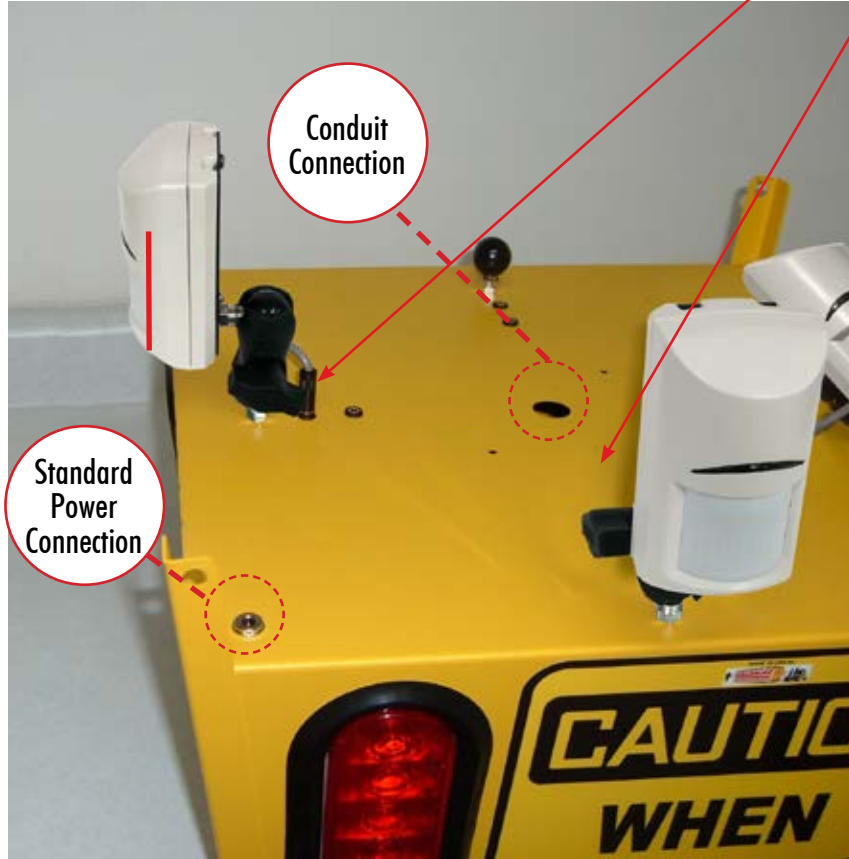

Powder Coated Steel Boxes



Optional Rack Mount



With Sensor

- Remote Sensor Standard on all models. Connect via 3.5mm jack 
- Quick release thumb lever
- Great for hearing impaired personnel
- Sensor Indicator Light glows blue when sensor is activated
- Alerts pedestrians when forklifts are crossing
- Unit mounts up and out of the way
- No reflectors required
- No expensive microwave sensors
- Nothing attached to your forklifts
- Low voltage wiring eliminates the need for conduit. 24V transformer plugs into an overhead outlet power source
- Super bright LED lights with 100,000 hours life
- Sensors are factory pre-set to monitor from inches to 35' away.
- Sensor temperature ranges:
  - Standard Bosch: 14° F – 131° F
  - Low Temp Bosch: -40° F – 131° F
  - Exterior: -40° F – 122° F
  - The Fit sensor: -13° F – 140° F
- Audible option for loud environments or outdoors
- Injuries & fatalities as a result of forklift collisions can be eliminated
- Externally mounted optional universal transformer will handle incoming voltage from 277V to 24V as required
- Indoor, outdoor and cooler applications
- Significant loss prevention benefits
- Remote Sensor may be mounted to rack for superior detection
- All models can ship via UPS



# LOOK OUT SENSORS HELP

## FOR TYPICAL FORKLIFT TRAFFIC ALERTS

Each sensor alerts the opposite corner and both sensors can be activated simultaneously. Units include mounting hardware and install in minutes. UL listed for US and Canada.

### LOOK OUT 1



- End of the rack aisles
- Wall mount for end of aisle obstructions
- Uses a single set of flashing LED lights

### LOOK OUT 2



- An additional set of lights that alternate when activated
- Units include a 24 volt plug-in wall transformer into a 110 VAC receptacle with 25' of low voltage cord

### LOOK OUT 3

Rack Mount



Front view



Rear view

- Monitor 3-way intersections and alert all directions
- Two sensors monitor the main aisle while a third monitors the row that meets the main aisle to provide an alert in 3 directions
- 25' power cord is recommended

Standard Power Jack

Part Number	# of Boxes	# of Lights	# of Sensors	Recommended Power Cord	Universal Transformer	Audible	Detection Range
Look Out 1	1	2	2	25' for 110 Vac	Optional	Optional	99.9% @35'
Look Out 2	1	4	2	25' for 110 Vac	Optional	Optional	99.9% @35'
Look Out 3 (Rack Mounted)	1	2 sm & 2 lg	3	25' for 110 Vac	Optional	Optional	99.9% @35'

# PROTECT YOUR ENTIRE FACILITY!

## LOOK OUT 1 EXTERIOR

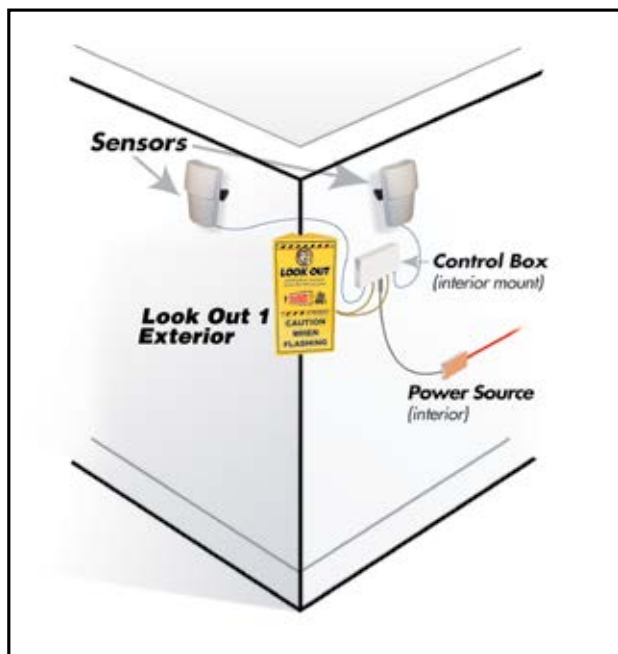

**Control Box**



**Exterior Sensors**

• Powder coated stainless steel box for durability  
15' Power cord recommended.

**21 LED Lights!**

## LOOK OUT 2, 3 & 4

Hanging Mount



- For 2, 3 or 4-way intersections to monitor and alert just around the corner
- Sensor range is 35' away and 40' wide, adequate distance to stop a fork truck traveling at OSHA recommended speeds
- 50' power cord is recommended
- Optional "Brilliant" lights for mounts above 20'

Part Number	# of Boxes	# of Lights	# of Sensors	Recommended Power Cord	Universal Transformer	Audible	Detection Range
Look Out 1 Exterior (Brilliant)	2	2	2	15' for 110 Vac	Optional	Optional	99.9% @40'
Look Out 2 (Large Box)	1	2	2	50' for 110 Vac	Optional	Optional	99.9% @35'
Look Out 3	1	3	3	50' for 110 Vac	Optional	Optional	99.9% @35'
Look Out 4	1	4	4	50' for 110 Vac	Optional	Optional	99.9% @35'

# DOOR MONITOR SENSORS ALERT OFFICE

**OFFICE DOOR MONITOR, HALL DOOR MONITOR BASIC AND HALL DOOR MONITOR 1** are your primary lines of defense designed to alert individuals as they approach a doorway. Before they pass through, sensor(s) on the other side of the door detect motion so the pedestrian does not walk out into forklift traffic.

## OFFICE DOOR MONITOR



Low profile office box

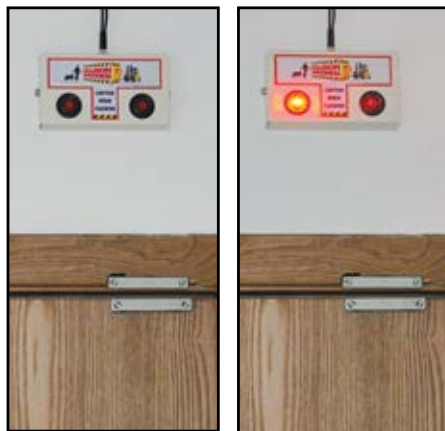

Non-activated    Activated

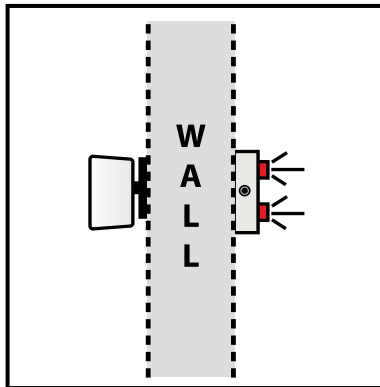

Top View

## HALL DOOR MONITOR BASIC

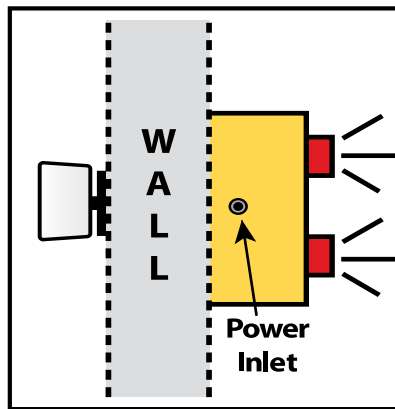

Top View

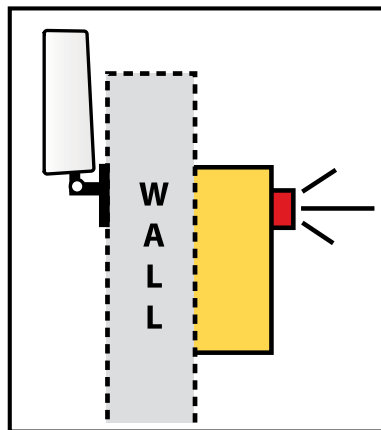

Side View

## HALL DOOR MONITOR 1

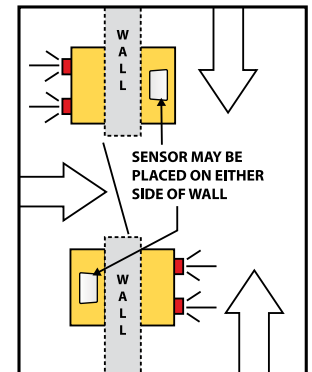

Top View

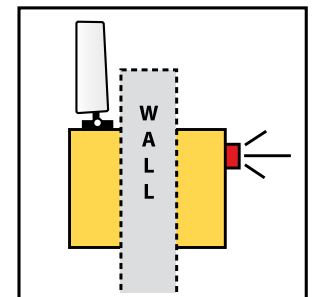

Side View

Part Number	# of Boxes	# of Lights	# of Sensors	Recommended Power Cord	Universal Transformer	Audible	Detection Range
Office Door Monitor	1 micro	2 small	1 remote	15' for 110 Vac	Optional	N/A	99.9% @35'
Hall-Door Monitor Basic	1 small	2 small	1 remote	15' for 110 Vac	Optional	Optional	99.9% @35'
Hall-Door Monitor 1	2 small	2 small	1	15' for 110 Vac	Optional	Optional	99.9% @35'

# PERSONNEL AND FORKLIFT OPERATORS

**HALL DOOR MONITORS 2, 3 & 4** include sensors to detect pedestrians as they approach the door and alert the forklift driver as they pass by the doorway, creating a safety zone. These six package sets of **HALL DOOR MONITORS** illustrate the options available. We can also develop custom options for your specific needs. 15' power cord is recommended.

## HALL DOOR MONITOR 2

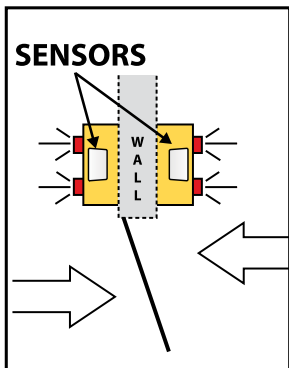

Top View

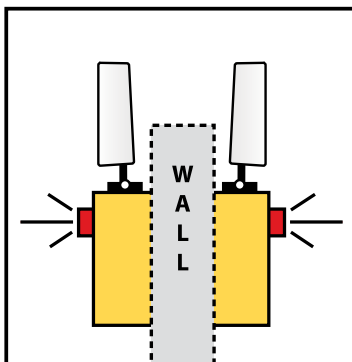

Side View

## HALL DOOR MONITOR 3

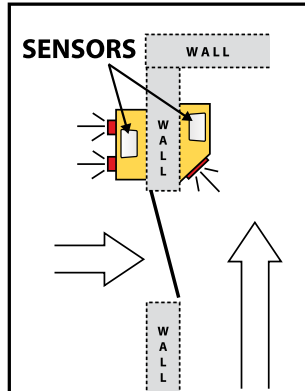

Top View

## HALL DOOR MONITOR 4

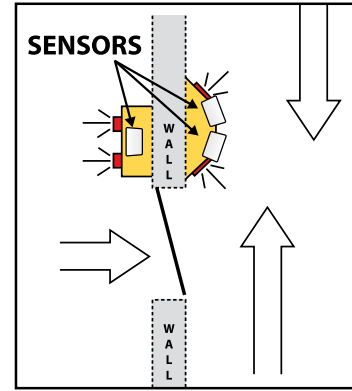

Top View



Part Number	# of Boxes	# of Lights	# of Sensors	Recommended Power Cord	Universal Transformer	Audible	Detection Range
Hall-Door Monitor 2	2 small	4 small	2	15' for 110 Vac	Optional	Optional	99.9% @35'
Hall-Door Monitor 3	1 small 1 single	2 small & 1 large	2	15' for 110 Vac	Optional	Optional	99.9% @35'
Hall-Door Monitor 4	1 small 1 double	2 small & 2 large	3	15' for 110 Vac	Optional	Optional	99.9% @35'

# OVERHEAD DOOR MONITORS HELP KEEP

**OVERHEAD DOOR BASIC, OVERHEAD DOOR 1 and OVERHEAD DOOR 2** are your primary lines of defense designed to alert operators and individuals as they approach an overhead doorway. Before they pass through, sensor(s) on the other side of the door detect motion so pedestrians and operators are alerted.

## OVERHEAD DOOR BASIC

Single Alert

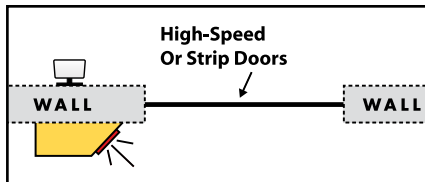

Top View

## OVERHEAD DOOR BASIC

Double Alert

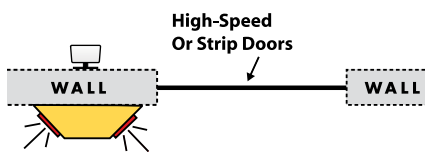

## OVERHEAD DOOR 1

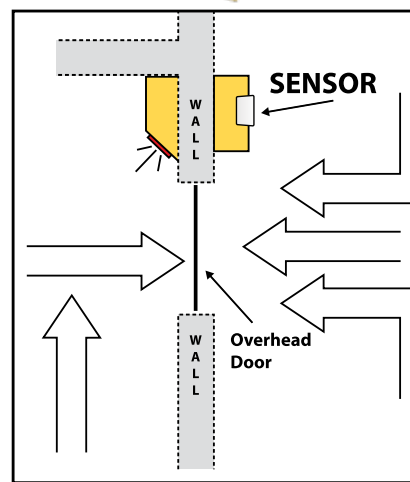

Top View

## OVERHEAD DOOR 2

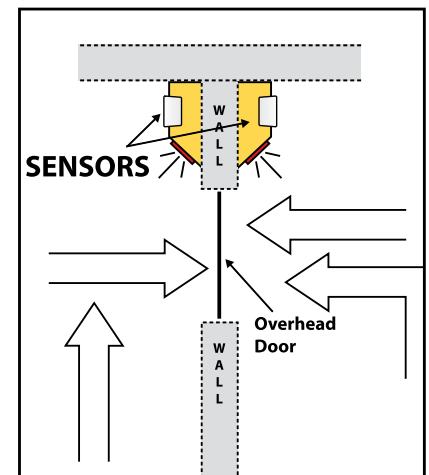

Top View

Part Number	# of Boxes	# of Lights	# of Sensors	Recommended Power Cord	Universal Transformer	Audible	Detection Range
Overhead Door Basic Single	1 sgl	1	1 remote	15' for 110 Vac	Optional	Optional	99.9% @35'
Overhead Door Basic Double	1 dbl	2	1 remote	15' for 110 Vac	Optional	Optional	99.9% @35'
Overhead Door 1	1 sm & 1 sgl	1	1	15' for 110 Vac	Optional	Optional	99.9% @35'
Overhead Door 2	2 sgl	2	2	15' for 110 Vac	Optional	Optional	99.9% @35'

# HIGH-SPEED INTERIOR DOORWAYS SAFE!

**OVERHEAD DOOR 3 & 4** expand your area of defense with multiple sensors to alert operators and individuals as they approach an overhead doorway. The additional radius of sensors will help protect high-traffic areas and areas that may consist of permanent and temporary obstructions which block the view of approaching traffic.

## OVERHEAD DOOR 3

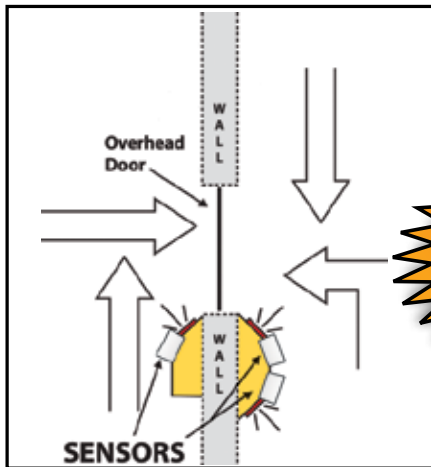

Top View

## OVERHEAD DOOR 4

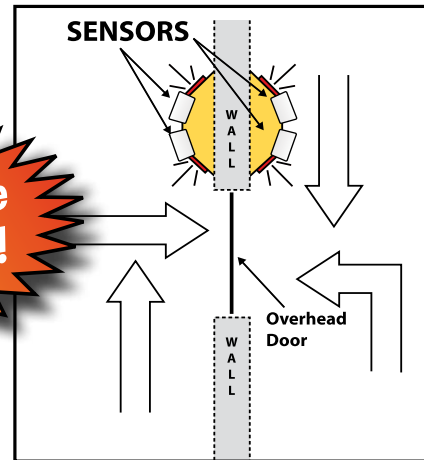

Top View

**Now Available for Outdoors!**



### GREAT FOR:

- Expensive high speed doors
- Strip doors

Part Number	# of Boxes	# of Lights	# of Sensors	Recommended Power Cord	Universal Transformer	Audible	Detection Range
Overhead Door 3	1 sgl & 1 dbl	3	3	15' for 110 Vac	Optional	Optional	99.9% @35'
Overhead Door 4	2 dbl	4	4	15' for 110 Vac	Optional	Optional	99.9% @35'

# FLOOR BURST

## AN ADDITIONAL BURST OF SAFETY!

Too often employees can become distracted and miss important warning devices. Our new Floor Burst option provides an extremely fast pulsating light that illuminates the floor of an intersection before traffic passes through. This feature is offered on all of our ceiling hung models, Look Out 2, 3, & 4.



Fast Pulsating Burst

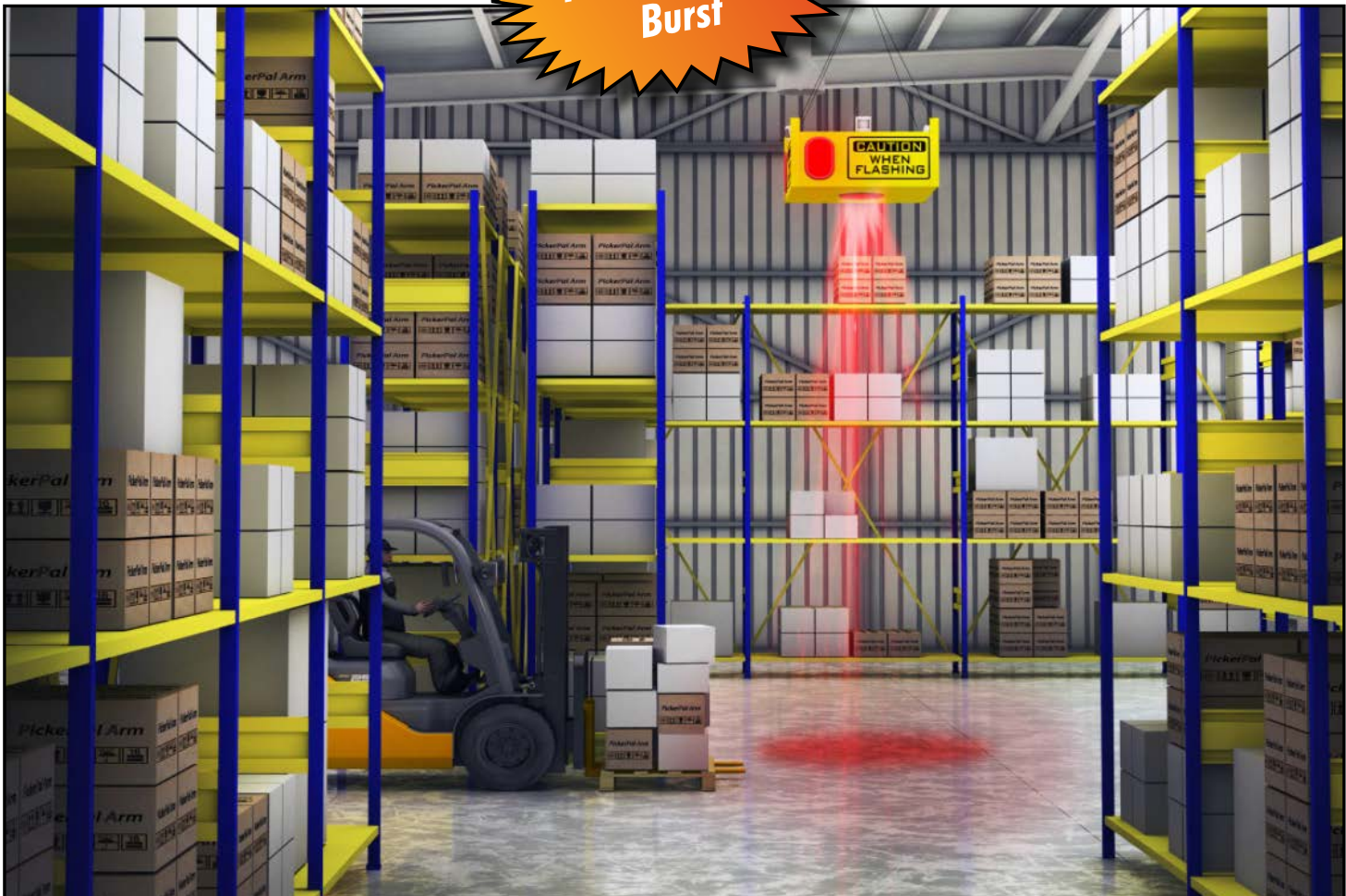

# THE 'FIT' SENSORS

## THE 'FIT' HEIGHT WARNING SENSORS

The 'FIT' height warning sensors alert fork truck drivers of overhead obstacles that may be in the line of an elevated mast. When sensor beams are broken, The 'FIT' lights and audible continuously alert the driver to potential danger. Sensors can be mounted or hung to protect obstacles. 15' foot power cord is recommended.

### THE 'FIT' HEIGHT WARNING SENSORS



### **GREAT FOR:**

- Sprinkler heads above rack
- Overhead heaters
- Overhead lights
- Ceiling fans
- Rack tunnels
- Overhead storage
- Air handlers
- Interior doorways

Part Number	# of Boxes	# of Lights	# of Sensors	Recommended Power Cord	Universal Transformer	Audible	Detection Range
FIT Package 1	1	2	1 sets	15' for 110 Vac	Optional	Included	99.9% @35'
FIT Package 2	1	2	2 sets	15' for 110 Vac	Optional	Included	99.9% @35'
FIT Package 3	1	2	3 sets	15' for 110 Vac	Optional	Included	99.9% @35'

# DOCK WATCHER SENSORS

## KEEP DOCK TRAFFIC WORKING WITH SAFETY IN MIND!

### DOCK DOOR MONITORS

**DOCK DOOR MONITORS** have a wall mounted arm with a swivel feature that allows the Exterior sensor to monitor activity in a trailer. As the fork truck backs out, the bright flashing strobe warns co-workers. This model is available with an Interior sensor for interior docks. Plugs in directly to a 110 Vac outlet.



### DOCK WATCHERS

**DOCK WATCHER 1** is designed to monitor one or two dock doors. It senses motion and warns operators and pedestrians of impending danger. It is a ceiling hung sensor that mounts high enough to allow all mobile traffic to clear.

By adding remote sensors you create **DOCK WATCHER 2, 3, or 4**. Specify the cable length needed for each remote sensor. Sensors can point to door locations and also identify motion in traffic areas near the loading dock. Unit hangs from your chain.

### DOCK WATCHER 1

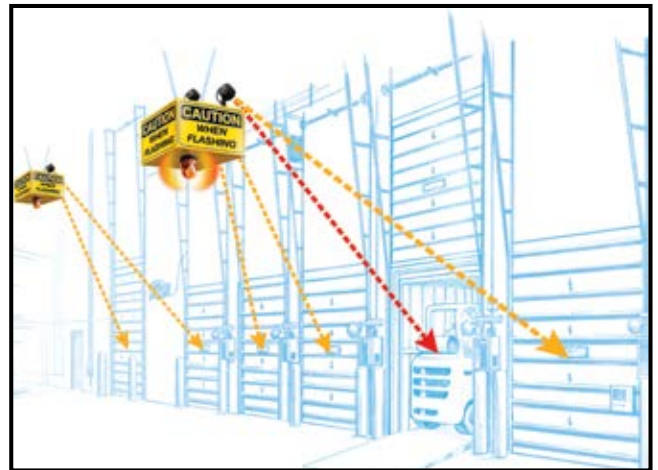
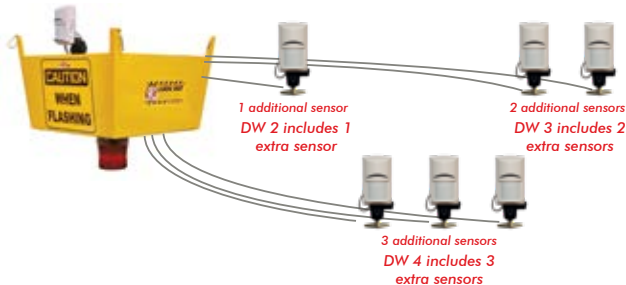

**Dock Watcher 1:** 1-2 Doors  
**Dock Watcher 2:** 3-4 Doors

Part Number	# of Boxes	# of Lights	# of Sensors	Universal Transformer	Audible	Detection Range
Dock Door Monitor EXT	24" Swivel Arm	1 strobe	1 Exterior	N/A	N/A	99.9% @ 35'
Dock Door Monitor	24" Swivel arm	1 strobe	1 Interior	N/A	N/A	99.9% @ 35'
Dock Watcher 1	1	1 strobe	1	Opt	Recommended	99.9% @ 35'
Dock Watcher 2	1	1 strobe	1 & 1 remote	Opt	Recommended	99.9% @ 35'
Dock Watcher 3	1	1 strobe	1 & 2 remote	Opt	Recommended	99.9% @ 35'
Dock Watcher 4	1	1 strobe	1 & 3 remote	Opt	Recommended	99.9% @ 35'

# TRAFFIC ALERTS

**Unwanted traffic behind your building?  
Uncomfortable about opening the rear door at night?  
Use TRAFFIC ALERT to detect unauthorized traffic.**

## Typical Strip Mall Application

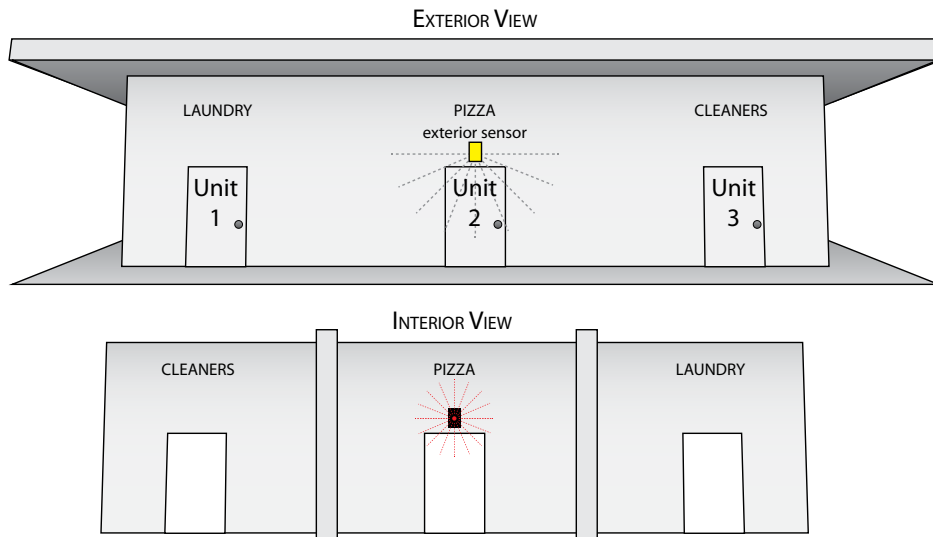

**Choose one or two exterior sensors, then choose which light or box works for your facility. Audible alert available on some models, audible **ONLY** models available.**



**Strobe**



**Hall**



**DOD**



**Office**

## GREAT FOR:

- Strip Malls
- Apartment Buildings
- At Entrance Gates
- Distribution Center Security
- Home Garages
- Restaurants
- Free Standing Buildings

Part Number	# of Boxes	# of Lights	# of Sensors	Recommended Power Cord	Universal Transformer	Audible	Detection Range
Traffic Alert Ext 1 DOD	1 double	2 large	1	15'	Opt	Opt	99.9% @ 40'
Traffic Alert Ext 2 DOD	1 double	2 large	2	15'	Opt	Opt	99.9% @ 40'
Traffic Alert Ext 1 Office	1 micro	2 small	1	15'	Opt	N/A	99.9% @ 40'
Traffic Alert Ext 2 Office	1 micro	2 small	2	15'	Opt	N/A	99.9% @ 40'
Traffic Alert Ext 1 Hall	1 small	2 small	1	15'	Opt	Opt	99.9% @ 40'
Traffic Alert Ext 2 Hall	1 small	2 small	2	15'	Opt	Opt	99.9% @ 40'
Traffic Alert Ext 1 Strobe	1 control box	1 strobe	1	15'	Opt	Opt	99.9% @ 40'
Traffic Alert Ext 2 Strobe	1 control box	1 strobe	2	15'	Opt	Opt	99.9% @ 40'

# FEATURES & OPTIONS

## Sample Warehouse Configuration of Collision Awareness Sensors

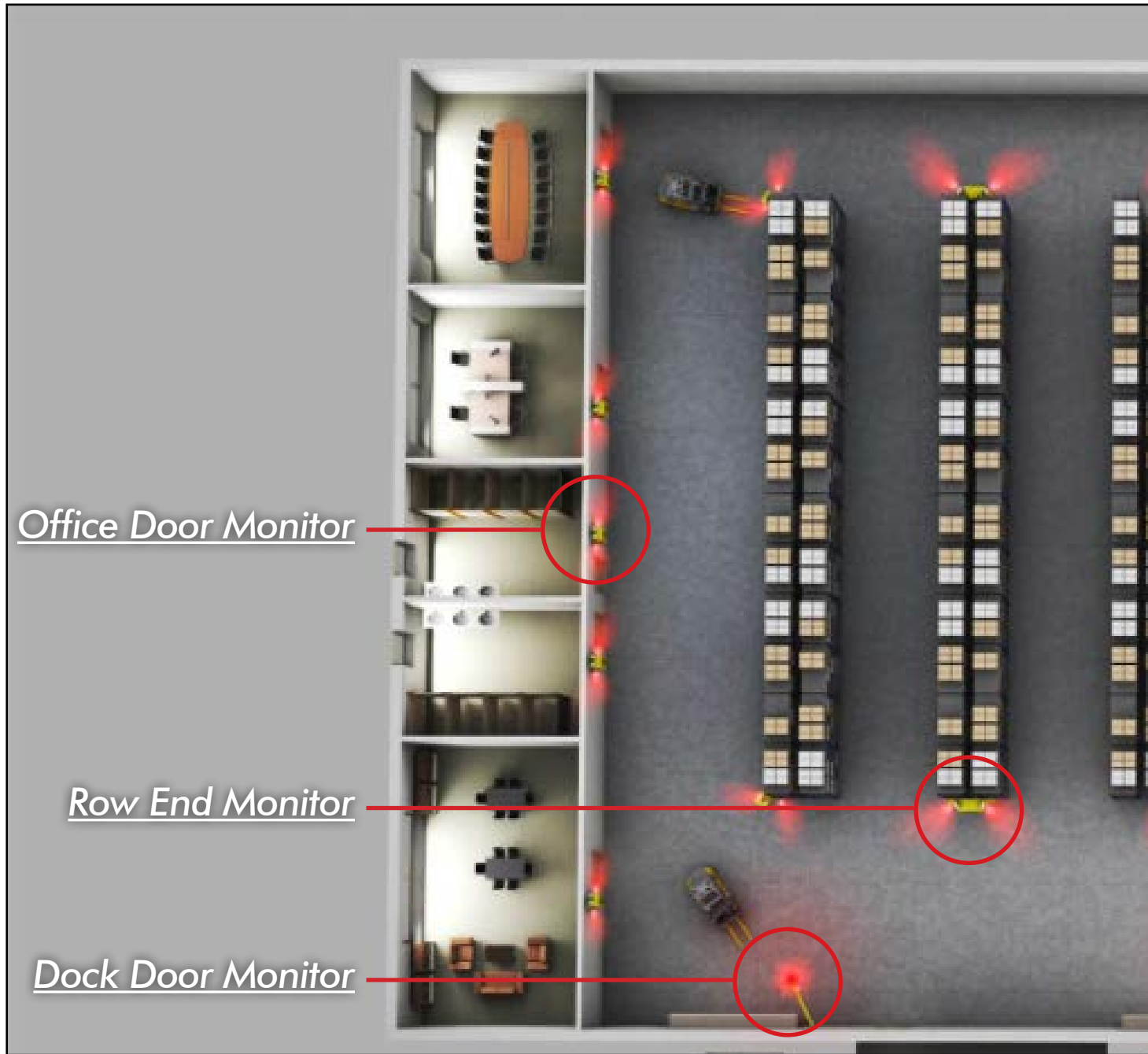

Office Door Monitor

Row End Monitor

Dock Door Monitor

### OPTIONAL AUDIBLE ALERTS

Audible alerts can be installed on specific products. They are usually mounted on the bottom of the unit and may be disconnected at any time.



# TYPICAL WAREHOUSE APPLICATIONS

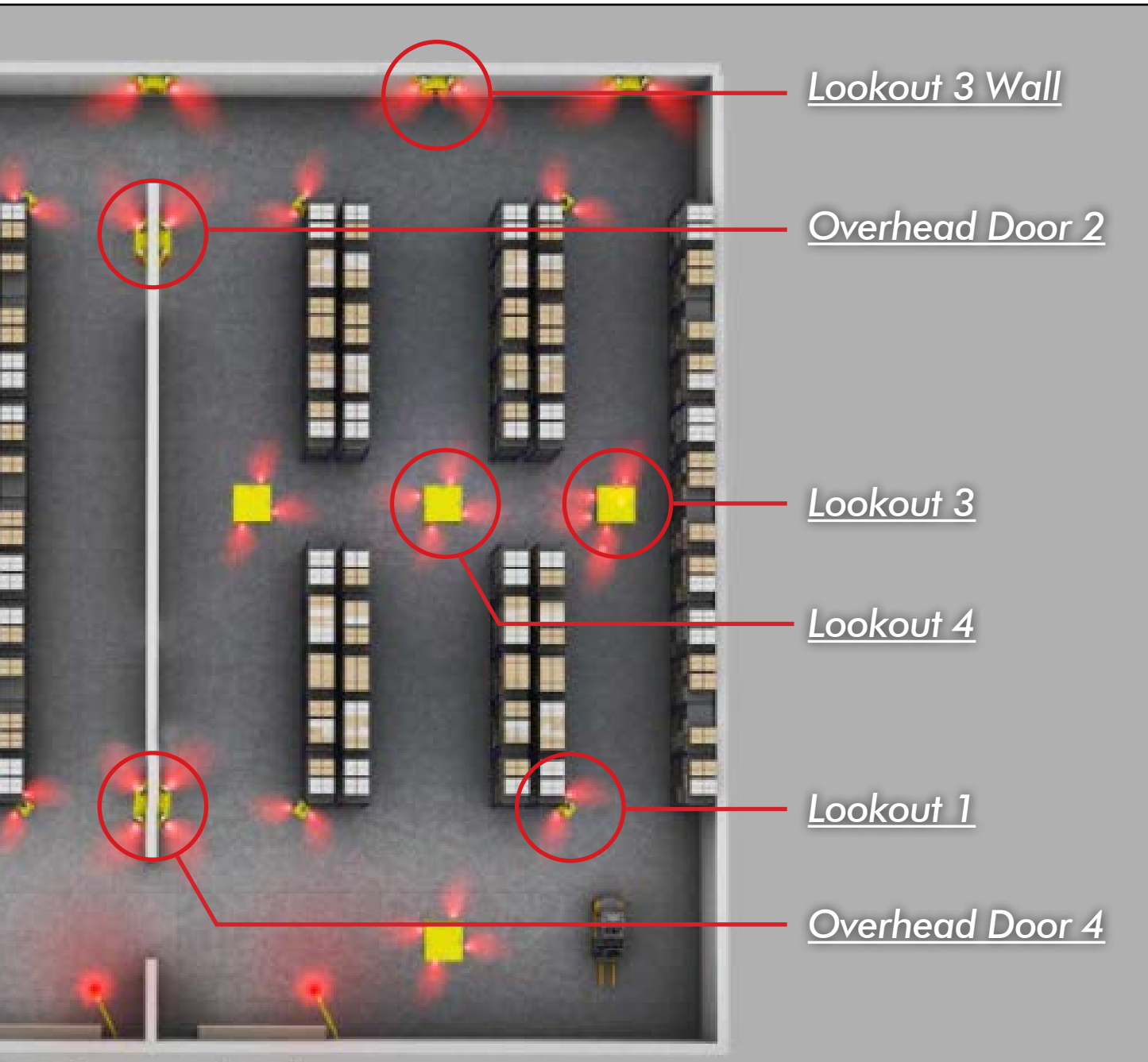

We can help customize a configuration for your warehouse facility.  
Call us today to get started!

- Avoid Forklift Accidents
- Alert Workers & Pedestrians
- Warehouse, Yard and Office Applications
- Reduce Liabilities
- Increase Up Time



*Let pedestrians and operators know if someone is just around the corner with our New LOOK-OUT™*

# LEADERS OF INTERSECTION PROTECTION OUR FACILITY PROTECTION PARTNER

## "Save"ty® Yellow Products



Self Closing Swing Gate



Protecting an Office



Guarding Equipment



Guarding Standard Conveyor



Guarding Overhead Conveyor



Guarding Battery Racks



Guarding Electrical Panels



Panoramic View

**Collision Awareness Products**  
 3550 Legacy Blvd.  
 St. Charles, IL 60174  
 Toll FREE: 888-324-1920  
 Sales@CollisionAwareness.com

